

# **WILDVIEW**

**EZ Cam Series**

**User's Manual**



**Toll Free Customer Support 1-888-304-6125**

**[www.wildviewcam.com](http://www.wildviewcam.com)**

Wildview EZ Cam

**For Customer Service or Warranty Information Call Toll Free**

**888-304-6125**

WILDVIEW

P.O. Box 535189

Grand Prairie, Texas 75053-5189

**Wildview EZ Cam Limited Warranty**

**Your Wildview scouting camera is covered by a One Year Limited Warranty on parts and labor from the date of original purchase, and purchases must be made through an authorized dealer. The warranty covers defects in workmanship and materials. The warranty does not apply to units, which have been damaged or abused intentionally or unintentionally. A purchase from individuals or unauthorized internet sites such as eBay voids the warranty.**

**Tampering with or altering the unit will void the warranty. Any unauthorized service will void warranty. Original sales receipt must be produced for any warranty service and a Return Authorization (RA) number must be obtained from customer service at 888-304-6125 prior to returning product.**

## Manual Contents

Camera overview	4
Camera kit contents	6
Battery and memory installation	7
Definitions	11
Mounting the camera	14
Viewing images	18
Saving and deleting images	20
Memory compatibility chart	23
Image capacity chart	24
Technical specs	25
General information	27
Moon phase chart	29

## Wildview EZ Cam

### Camera overview

Front view

Side view

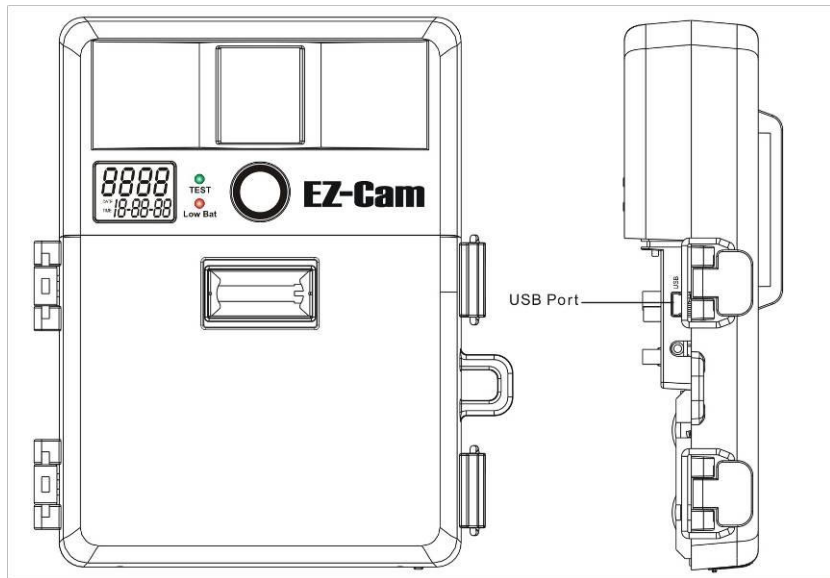

# Wildview EZ Cam

## Open view image with major parts indication

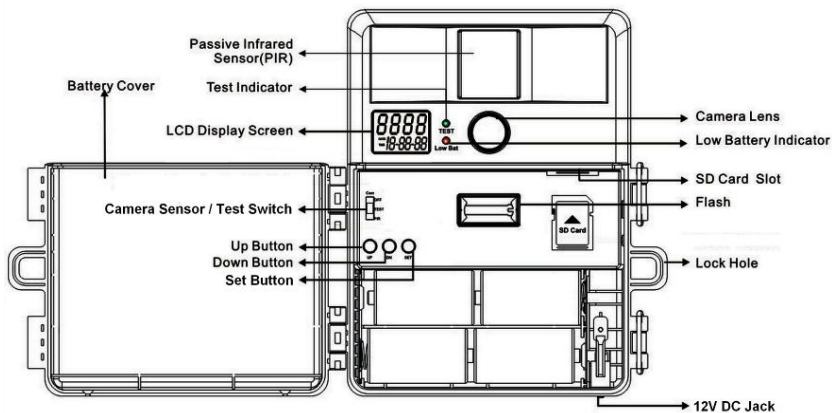

## Wildview EZ Cam

### **Camera kit contents**

- Wildview EZ Cam Digital Scouting Camera
- User manual
- Strap

## **Battery & memory installation**

**Warning:** Do not use a different Voltage lead acid battery other than the one specified in this section. Doing so will damage the camera and will void the warranty.

The Wildview EZ Cam is designed to operate using two different types of battery power options.

**NOTE:** Always have camera in the OFF position when installing or removing batteries. Removing battery while the camera is in operation may damage the camera.

### **Batteries “C” cell**

The internal battery compartment accepts 4 “C” cell batteries. Be sure to use high quality brand name alkaline batteries. Install batteries with correct polarity (+/-) as noted inside the battery compartment.

## Wildview EZ Cam

The Wildview EZ Cam is equipped with an external power jack designed to accept a barrel plug cable attached to a sealed lead acid battery. (sold separately). This will enhance the camera's field life. Battery cable and complete 12V Lead Acid battery kits are available wherever Wildview EZ scouting cameras are sold, or call toll free 888-304-6125. Only Wildview EZ cam external battery accessories are recommended.

- Insert the external battery barrel plug into the DC 12V jack on the bottom of camera housing.
  - Turn the camera power on.
  - The camera will automatically switch to external power when it is connected, even if the internal batteries are installed.
- ❖ ***Please make sure the voltage and polarity (+/-) are correct before connection. Incorrect voltage or polarity (+/-) will damage the camera.***

## Wildview EZ Cam

### **Memory Options**

Your Wildview EZ Cam scouting camera is equipped with 16MB SDRAM

The camera is also equipped with an expandable media card slot capable of accepting up to 2GB\* SD card (sold separately). With no memory card inserted into the slot, the camera will use the built in SDRAM memory to store images. If an SD card is inserted into the slot, then the camera will bypass the built in memory and utilize the SD memory. The front counter display will show the number of images in the built in memory, unless the expansion card is inserted at which point the front counter will only display the number of images stored in the expansion card.

## Inserting SD card

***Make sure camera is in the OFF position whenever adding or removing memory.***

- Insert SD memory card in to the SD card slot completely and in the correct direction, as shown by the SD picture shown on inner housing.
- To remove the SD memory card, depress the SD card and pull out the card gently.
- ❖ ***SD cards must be clean (no images from other sources).***
- ❖ ***If you are using the SD card from other cameras, please make sure to format the SD card in your computer prior to use in the camera. New cards are good to use straight from the package.***
- ❖ ***If installed SD card with lock, camera will show LOC on the display, please slide the lock switch to unlock location then reinstall the SD card.***

## Wildview EZ Cam

### Definitions

- **Resolution:** Preset at 1.3 Mega Pixels.
- **Day and Time:** Displays the **date and time that you have set** on still image.
- **Moon phase:** Displays the moon phase on still image.
- **Time out:** Preset at 1 minute interval.
- **Burst:** Preset to 3 continuous image capturing per PIR triggering.
- **FULL:** When memory capacity is full, the front LCD screen will show “FULL.”
- **Flash:** Preset to Auto.

## Set Date and Time

**The following setting must be performed before you use the camera.**

1. Turn on the Camera to set the Date / Time stamp.
  - a. Slide the power switch to the PIR position.
  - b. Press and hold [SET] button for 2 seconds to enter date & time setting mode.
  - c. The word "TIME" and first two digits of the time HH will blink. Press [UP] or [DN] to adjust the hour.
  - d. Press [SET] button to enter minute setting. Time and MM will blink. Press [UP] or [DN] to adjust the minute.
  - e. Press [SET] button to enter the month setting. Date & MM will blink. Press [UP] or [DN] to adjust month.
  - f. Press [SET] button to enter date setting. Date & DD will blink. Press [UP] or [DN] to adjust date.
  - g. Press [SET] button to enter year setting. Date & YY will blink. Press [UP] or [DN] to adjust year.

### Wildview EZ Cam

- h. Press and hold [SET] button for 2 seconds or until the Date icon stops blinking to exit the setting mode, and enter into PIR count down mode. Display will show date and number of pictures taken.

Once the program setting has been completed, slide the power switch to OFF position until you are ready for field use.

***WARNING: Date & Time setting will be lost whenever the batteries are removed from camera. You must re-set the Date & Time stamp after you replace the batteries.***

## Wildview EZ Cam

### Mounting the camera

It is recommended that you mount the camera 4-5 ft off the ground with the camera pointed at a slight downward angle. Be sure to avoid mounting the camera facing east or west, as the rising and setting of the sun could produce false triggers and overexposed images. Clear branches and other debris away from the front of the camera so as not to block the camera lens or PIR sensor.

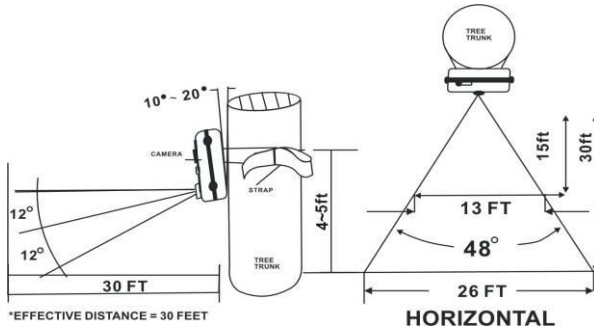

PIR Coverage Area Diagram

## Wildview EZ Cam

### Mounting the camera with the supplied strap:

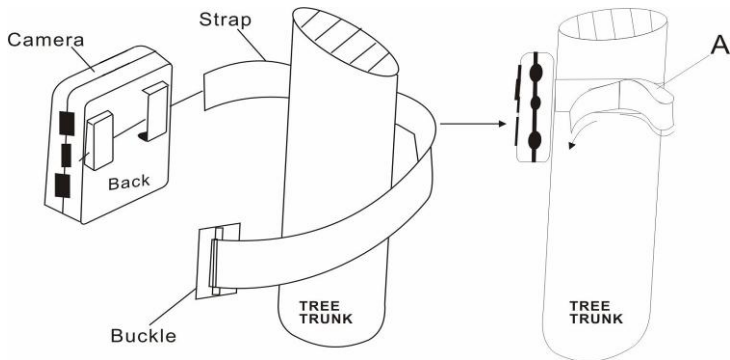

- Insert the strap through the strap slots on the rear housing.
  - Wrap the strap around the mounting surface. Secure the strap and tighten the buckle in order to secure the camera.
- ❖ ***In order to obtain proper weather resistance, please make sure that both door latches are securely locked in place.***

## Wildview EZ Cam

### **Testing the camera coverage area:**

One of Wildview EZ Scouting Camera's features is the ability to test the coverage area.

- After mounting the camera, open front housing and slide the power switch to Test position. The front LCD will display the word "tEst".
- Close the front housing.
- Walk around in the front of the camera to see if you have mounted the camera in the proper position. A green indicator light on the front will blink when you have intruded the coverage area.
- Adjust the camera position as needed and repeat testing until the desired coverage area is achieved.
- When you have completed testing the coverage area, open the front housing and slide the power switch from Test position to PIR position. Front LCD counter will show "0000". The camera will enter count down mode for 1 minute and the front green indicator will start blinking, giving you one minute to leave the coverage area. Then camera will enter PIR detection mode.

## Wildview EZ Cam

**NOTE:** Make sure you slide the power switch from TEST mode to PIR mode before you leave the field, otherwise the Camera will not take any pictures.

**Switch use:** Do not move the switch from TEST directly to PIR. Doing so will cause the camera not to operate. Slide the switch to OFF. Wait for the front LCD screen to turn off, and then slide the switch to PIR.

## Wildview EZ Cam

### Viewing images

#### Viewing images by computer download:

Your Wildview Scouting Camera is a plug and play USB storage device for users of Windows 2000 / ME / XP and Vista operating systems. This camera is not MAC compatible.

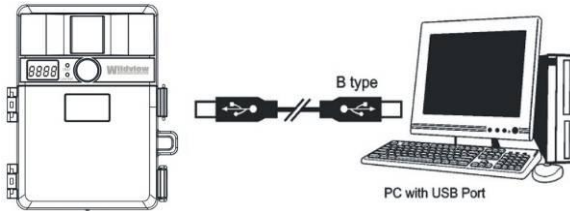

#### Viewing the images on your computer: (USB cable sold separately)

- Slide the power switch to OFF position.
- To view the images, simply plug one end of the USB cable into an available USB port on your computer.
- Plug the other end of USB cable into the camera. The camera will

Wildview EZ Cam  
automatically power ON. Front LCD screen will show "USb."

At the same time, your computer will recognize the camera as a mass storage device, and will be found under MY COMPUTER.

## **Saving and Deleting images**

### **SAVING IMAGES**

To save images on to your PC, simply copy and paste, or drag and drop from the memory to your PC desk top. Please note, if you use an SD card to save your images, the computer will display the images stored on the SD card. If no SD card is used, then the computer will display the images stored in the internal SDRAM.

### **DELETING IMAGES:**

There are two ways to delete the images from the memory, internal SDRAM or SD card, whichever you are using.

1. After you download the image onto your desk top, you can delete the image by: Unplug the USB Cable from camera. Slide the power switch to PIR position. LCD screen will display the number of images stored in the memory.
  - o Delete One picture:
    - a. Press [SET] button to enter delete setting. Display will show "ESC"
    - b. Press [UP] or [DN] to select d-ONE (delete one)
    - c. Press [SET] to delete the image. Press [UP] or [DN] until

## Wildview EZ Cam

screen shows “ESC” then press [SET] again to exit.

- d. This will only delete the last image saved in the memory.
  - Delete All pictures:
    - a. Press [SET] button to enter delete setting. Display will show “ESC”
    - b. Press [UP] or [DN] to select d-ALL (delete all)
    - c. Press [SET] to delete all images. The display will show “dONE” and will exit to count down mode automatically.
  - Format:
    - a. Press [SET] button to enter delete setting. Display will show “ESC”
    - b. Press [UP] or [DN] to select Ft (format)
    - c. Press [SET] to confirm. The display will show “dONE” and exit to count down mode automatically.
  - ESC: To exit delete setting.
2. Simply remove the batteries from the battery compartment. This will delete the image stored in the internal SDRAM memory only. If you are using an SD card as your storage device, you must delete images by following the step above.

## Wildview EZ Cam

### **CAUTION:**

***Do not remove the battery until you have downloaded all the images in the internal SDRAM. Once the battery is removed, all images in the internal SDRAM will be deleted. (This does not apply to images stored in SD card).***

***RED LED indicator will blink when battery is low. Turn off the camera. Download the pictures immediately. DO NOT attempt to replace the batteries before you have saved the images in your PC. Once the battery is drained completely, or if you attempt to replace the battery, all images in the internal SDRAM memory will be lost.***

## Wildview EZ Cam

### **SD card Compatibility Chart**

The following cards have been tested and approved for use in the Wildview series model.

Kingmax	2G
Sandisk	2G
Toshiba	2G
PNY	2G
Kingston	2G
First Champion	1G, 2G.
Digilux	1G, 2G.

Proper camera operation cannot be guaranteed when using memory cards **NOT** listed above.

Wildview EZ Cam  
**Image Capacity Chart**

(Based on image date size of 800KB)

<b>SD card</b>	<b># of Images</b>
Built In 16MB SDRAM	5
16MB	20
32MB	40
64MB	80
128MB	160
256MB	320
512MB	640
1GB*	1,280
2GB*	2,560

\* Subject to card compatibility under different brand

**NOTE:** Image Capacity Chart provides approximate number of images based on resolution settings and the size of memory card. These figures may vary depending on the amount of detail in the image.

## **Technical Specifications**

### **System Requirements and Compatibility**

- Windows Me/2000/XP/Vista
- Pentium 4, 2GHz or above
- 1GB RAM (2GB recommended)
- 32 bits color, resolution 800 x 600 or above. Built in 128MB video memory
- 2GB free hard disc space
- An available USB 1.1 port (USB 2.0 recommended)
- Direct X 9.0 or above – Should come with your operating system already.
- Optional: Windows compatible sound card and speaker

❖ ***If you have any questions regarding your PC specifications, please call your PC manufacturer.***

## Wildview EZ Cam

### Camera Features and Specification

- Auto white balance and auto expose
- Flash Range – 30ft
- 4 digits LCD Image counter
- Battery low indicator
- Green Test LED indicator
- Focusing: 5 ft to infinity
- High precision multi-layer glass lens with coating
- Effective viewing Angle: 52 degrees
- PIR detection angle 48 degrees
- Low power consumption:
  - Standby current: < 6mA
  - Capture current: <120mA
- Interface type: USB 1.1
- Power: “C” size alkaline Batteries x 4
- Image format: Standard JPEG

## **General Information**

### **Storing conditions**

- Store in cool and dry location when it's not in use.
- Operating Environment: 14 to 104 deg F (-10 to 40 deg C). 20-85% relative humidity, non-condensation.

### **Special care instructions!!**

- The camera is designed to be weather resistant. Never attempt to immerse the unit in water or any other liquid. This will damage the unit and void the warranty.
- Use a soft lens cloth for cleaning the lens. Avoid touching lens with fingers.
- Remove dirt or stains with a soft cloth dampened with water or neutral detergent. Keep the Wildview EZ scouting camera in a dry and cool dust-free environment, or container when it is NOT in use.
- Take the batteries out, when the Wildview EZ scouting camera is NOT to be used over a long period.
- Avoid dropping the Wildview EZ scouting camera on to hard

## Wildview EZ Cam

ground. Do not disassemble the Wildview EZ scouting camera.

- Do not mix new and old batteries.
- Do not open the camera for unauthorized service. This could cause serious damage to the unit and will void the warranty.

This camera is a precision electronic device. Do not attempt to service this camera yourself, as opening or removing covers may expose you to dangerous voltage points or other risks.





































**Caution:** When camera is turned off, if there is any residual power left in the camera, it will take an extra picture to discharge the remaining power in the camera. Under low lighting conditions, the flash will go off.

May be protected by one or more U.S. Patent numbers:

6,735,387 / 6,768,868 / 6,834,162 / 7,149,422 / 7,308,196 / 7,593, 632

# Wildview EZ Cam

## **Moon Phase Symbol Chart**

Symbol	Lunation from to		Actual phase					
	1	5						
	6	10						
	11	14						
	15	16						
	17	20						
	21	25						
	26	29 or 30						

## Wildview EZ Cam

### ***Caution:***

Modification not approved by the party responsible for compliance could void user's authority to operate the equipment

### ***FCC Compliance***

This equipment has been tested and found to comply with the limits for Class B digital device, pursuant to part 15 of the FCC Rules. These limits are designed to provide reasonable protection against harmful interference in a residential installation. This equipment generates uses and can radiate radio frequency energy and, if not installed and used in accordance with the instructions, may cause harmful interference to radio or television receptions, which can be determined by turning the equipment off and on, the user is encouraged to try to correct the interference by one or more of the following measure:

- ❖ Reorient or relocate the receiving antenna.
- ❖ Increase the separation between the equipment and the receiver.
- ❖ Connect the equipment into an outlet on a circuit different from that to which the receiver is connected.
- ❖ Consult the dealer or an experienced radio/TV technician for help.

**Product specifications are subject to change. Wildview is not responsible for any photographic or typographical errors.**